

GReddy Turbo Kit

Acura RSX Type-S DC5 (K20A) T517Z 8cm²

Acura RSX Type-S DC5 (K20A) T517Z 8cm²

Installation Manual

Please read the entire manual before installing this kit.

Application:

Make	Model	Chassis	Year
Acura	RSX Type-S	DC5	02~03

- This **GReddy Turbo Kit** is designed only for the vehicles specified above.
- **GReddy Front mount intercooler kit** is recommended with this kit
- Premium grade gasoline (92 octane or higher) is required with this Kit.
- Make sure that the vehicle is not equipped with any ECU upgrade chips.
- Use of **GReddy Racing Spark Plugs ISO #7** or NGK plugs (colder than factory) is recommended with this kit.

Important

- This installation should only be performed by a trained specialist who is very familiar with the automobile's mechanical, electrical and fuel management system.
- If installed by an untrained person, it may cause damage to the kit as well as the vehicle.
- GReddy Performance Products Inc. is not responsible for any damage to the vehicle's electrical system caused by improper installation.

1. Parts List

1.	Turbocharger T517Z 8cm ² P565	1
2.	Turbo Exhaust Manifold (Cast Iron)	1
3.	Down Pipe Adapter (Cast Iron-Steel 60Ø)	1
4.	Suction Pipe (Aluminum 60Ø)	1
5.	TZ suction flange (Aluminum 60Ø)	1
6.	Compression Pipe C-1 (Aluminum 50Ø)	1
7.	“ C-2 (Aluminum 60Ø)	1
8.	“ C-3 (Aluminum elbow No. 76 60Ø)	1
9.	Restrictor (Aluminum 43Ø)	1
10.	Airinx AY-MB (Blue filter)	1
11.	Airinx Adapter (M60)	1
12.	Fuel Injector 440cc (w/spacerx2, stud bolt x2 o-ringx8)	4
13.	“ Connector Harness	4
14.	e-Manage	1
15.	I/J Harness (18P)	1
16.	Ignition Harness (12P)	1
17.	Sensor Adapter Type-All US	1
18.	Oil Pressure Hose SUS 600mm	1
19.	“ Banjo Fitting male & female (small)	1set
20.	“ Copper Washer 10Ø (t=1.0mm)	2
21.	“ Three Way Fitting	1
22.	“ Union Fitting 1/8PT – 1/8 PT	1
23.	“ Union Fitting 1/8PT – 1/8PF 90°	1
24.	Oil Return Flange tube 16Ø (Turbo side)	1
25.	“ Banjo Fitting male & female 16Ø (Engine side)	1Set
26.	“ Banjo Spacer t=16	1
27.	“ Banjo Copper washer 15.5Ø (t=1.0mm)	3

1. Parts List

28.	Vacuum Hose (Blue) 5Ø x 200mm	(for Actuator)	1
29.	Rubber Hose	8Ø X 500mm (for Idle controller)	1
30.	Rubber Hose	16Ø X 400mm (for Oil return)	1
31.	Rubber Hose	19Ø X 190mm (for Blow by)	1
32.	Silicone Hose	60Ø x70mm	2
33.	Reducer Hose	50Ø – 60Ø	1
34.	Reducer Hose	60Ø – 70Ø	1
35.	Hose band	8Ø Tridon #4	2
36.	Hose band	16Ø Tridon #10	2
36.	Hose band	19Ø Tridon #12	2
38.	Hose band	50Ø Tridon #32	1
39.	Hose band	60Ø Tridon #36	7
40.	Hose band	70Ø Tridon #44	1
41.	Gasket	Turbo in	2
42.	Gasket	Turbo out	1
43.	Gasket	Turbine in	1
44.	Gasket	Turbine out	1
45.	Gasket	Down Pipe	1
46.	Gasket	Oil Return Flange Tube Small	1
47.	Heat Shield	Turbine	1
48.	Heat Shield	Down pipe	1
49.	Thermo-cloth	100mm X 1000mm sheet	4
50.	Zip ties	150mm	10
51.	Zip ties	200mm	5
52.	Three-way Vacuum Tee	10Ø-6Ø-10Ø	1
53.	Suction pipe bracket		1
54.	Oil return hose bracket		1
55.	Airinx hose fitting	8Ø-M18	1
56.	Intake Air Temperature Grommet		1

1. Parts List

57.	M6 X 10	P=1.0	B S/W F/W	- (Down pipe heat shield)	2
58.	M6 X 15	P=1.0	B S/W F/W	- (Suction pipe & compression pipe bracket)	2
59.	M6 X 15	P=1.0	B S/W F/W N	(Suction pipe bracket)	1
60.	M6 X 15	P=1.0	B S/W	- - (Oil Return Bracket)	2
61.	M8 X 15	P=1.25	B S/W F/W	- (Turbine heat shield)	2
62.	M8 X 30	P=1.25	B S/W F/W N	(Compressor inlet)	2
63.	M8 X 20	P=1.25	B S/W F/W	- (Compressor outlet)	2
64.	M8 X 30	P=1.25	B S/W	- N (Exhaust manifold – Turbo in flange)	7
65.	M8 X 75	P=1.25	B S/W	- - (Turbine out)	2
66.	M8	P=1.25	- - -	N (Down pipe)	2
67.	M10 X 45	P=1.25	B S/W F/W N	(Ex. Manifold)	3

1. Parts List

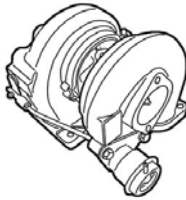

1



2

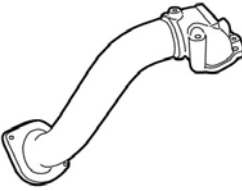

3

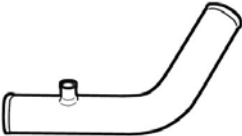

4



5

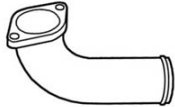

6

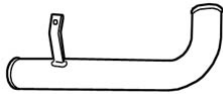

7



8



9



10



11

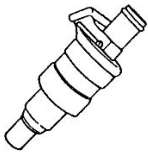

12

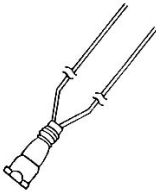

13



14



15-16



17



18

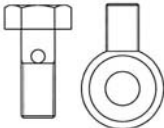

19



20

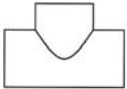

21

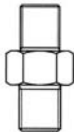

22

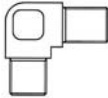

23



24

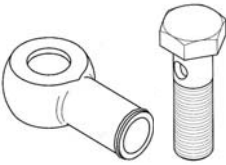

25

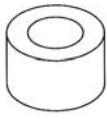

26

1. Parts List



27



28~31



32



33~34

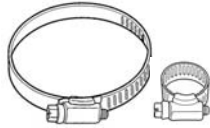

35~40

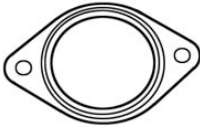

41

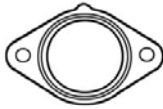

42

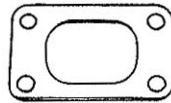

43



44



45



46



47

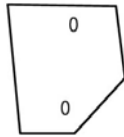

48

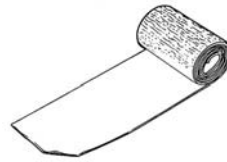

49



50~51



52

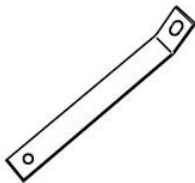

53



54



55



56

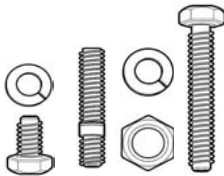

57~67

2. Removal of Stock Parts

When removing the stock parts, make sure you read over the factory repair manual for proper procedures.

- 2-1 Disconnect the negative terminal of the battery.
- 2-2 Release the fuel pressure in the fuel system by loosening the fuel pulsation damper on top of the fuel rail. (see factory repair manual for detail procedure).
- 2-3 Drain the engine oil.
- 2-4 Remove the front strut bar and it's brackets.
- 2-5 Remove the engine cover.
- 2-6 Remove the Air cleaner assembly with intake tube, breather hose and Intake temperature sensor.
- 2-7 Disconnect the primary and secondary O2 sensor and remover the catalytic converter.
- 2-8 Remove the VTEC solenoid valve assembly.
- 2-9 Remove the exhaust system heat shield and manifold.
- 2-10 Remove the heat shield plate (bottom of the firewall) and the intermediate drive shaft heat shield.

3. Kit Installation

3-1 Factory heat shield modification

- (1) Heat shield plate modification
Trim the shaded area on the heat shield plate that was removed as shown.

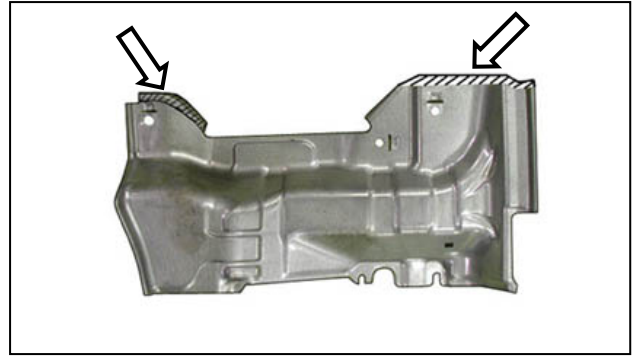

- (2) VTEC Solenoid Valve Assembly heat shield Modification.
Trim the shaded area on the heat shield that was removed as shown.

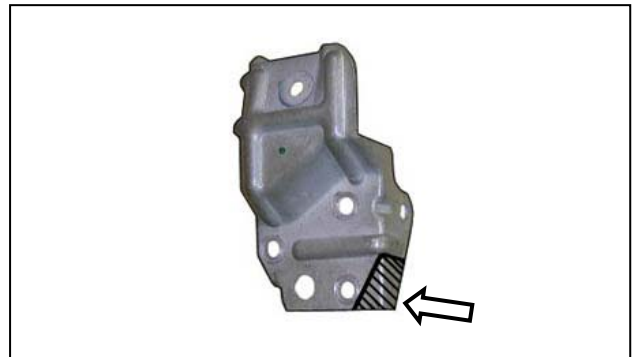

3-2 Thermo Cloth Installation

- (1) Disconnect the Crank sensor and Oil Pressure Sensor connector and wrap the thermo cloth to the harness as shown.
- (2) Wrap the thermo cloth to the power steering line by the fire wall.

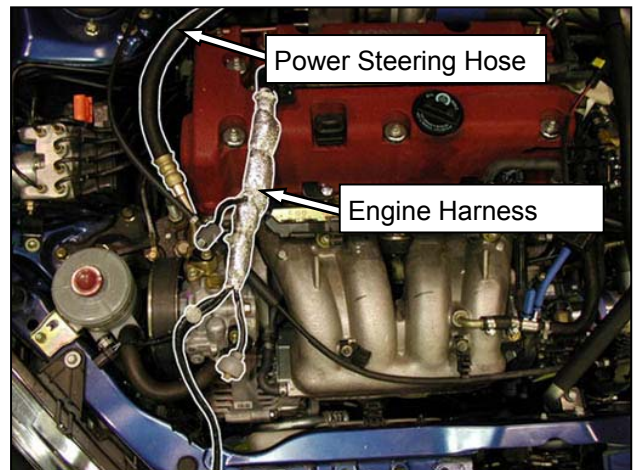

- (3) Wrap the thermo cloth to the engine harness and the heater hoses by the fire wall.



3-3 Power Steering Line Modification

Remove the power steering bracket off the line and valve cover. Bend the Power steering line so that the line routes closer towards the shock tower. Make sure not to kink or break the line.



3-4 Oil Pressure Line Installation

(1) Remove the Oil Pressure switch and install the union fitting and 3-way fitting on to the block.

* Use Teflon tape on the thread.

* Point the 3-way fitting outlet where the oil pressure switch is going to be installed to 2 o'clock.

(Parts used #21,22,23)

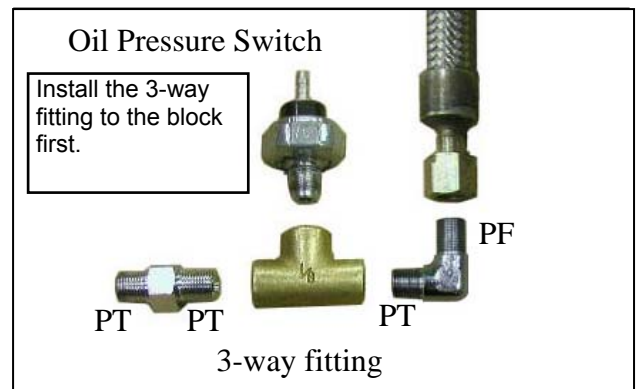

(2) Install the oil pressure switch to the 3-way fitting and reinstall the VTEC solenoid assembly with the modified heat shield.

* Make sure that the heat shield does not hit the oil pressure switch.

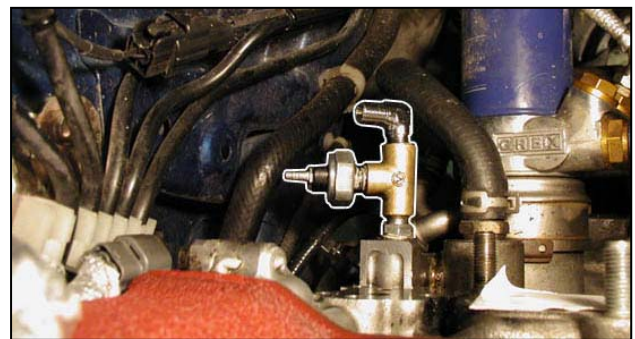

(3) Reconnect the oil pressure switch harness and the crank sensor.

(4) Connect the oil pressure line to the installed union fitting.

(Parts used #18)



3-5 Exhaust Manifold Installation

- (1) Install three stud bolts on to the cylinder head as shown.

(Parts used #67)



- (2) Install the exhaust manifold using the factory gasket.

- * Use a new exhaust manifold gasket.
- * Use factory nuts on the top side of the flange.

(Parts used #2, 67)



3-6 Turbocharger Installation

- (1) Wrap the thermo cloth the actuator as shown.

- * The heat off the manifold can damage the actuator with out the thermo cloth.

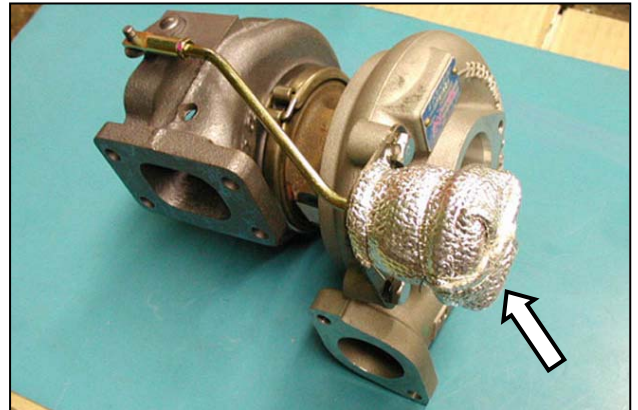

- (2) Install stud bolts on to the exhaust manifold, then mount the turbocharger to the manifold using provided gasket.

(Parts used #1,43,64)



3-7 Oil Pressure Line Connection

- (1) Connect the oil pressure line that was installed in step 3-4 to the turbo using banjo fitting and copper washers. As shown.

* Point the banjo fitting towards the firewall.

(Parts used #19,20)

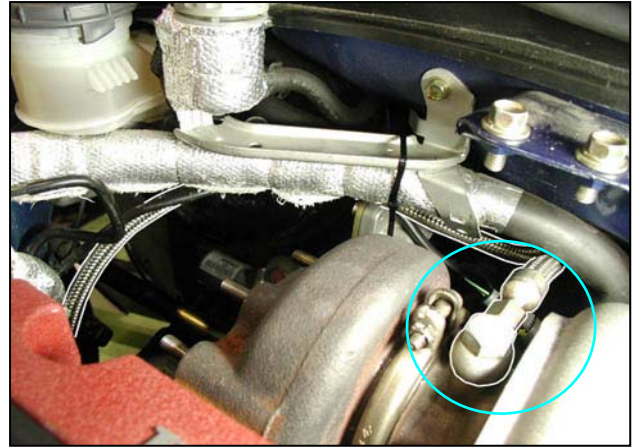

3-8 Oil Return Installation

- (1) Install the provided oil return pipe to the turbocharger using the provided gasket and hardware as shown.

(Parts used #24, 46, 60)

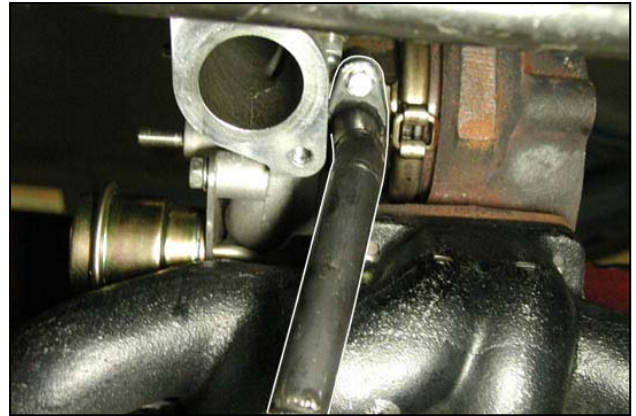

- (2) Remove the oil drain bolt and install the provided oil return banjo bolt using spacer and copper washers as shown.

(Parts used #25, 26, 27)

- (3) Wrap the provided 16Øhose with thermo cloth. Then install the hose to connect the oil return pipe from the turbo to the oil return banjo fitting on the oil pan.

* Route the hose behind the intermediate drive shaft as shown.

(Parts used #30, 36, 49)



- (4) Install the Oil return hose bracket to the block and secure the hose to the bracket using provided zip ties as shown.

(Parts used #50, 54)

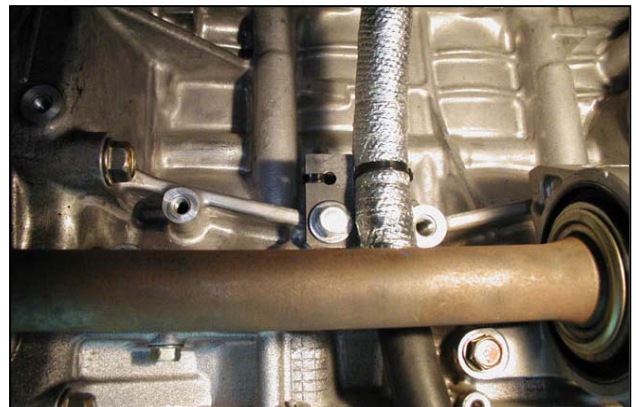

- (5) Modify the drive shaft heat shield by cutting the shaded area in the picture to prevent the hose from rubbing up on the shield.

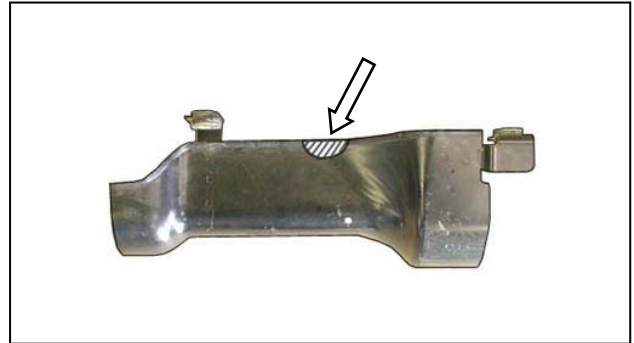

- Reinstall the heat shield and make sure there are enough clearance between the hose and the shield and the drive shaft.
 - * Oil return hose to heat shield: 10mm
 - * Oil return hose to drive shaft: 20mm

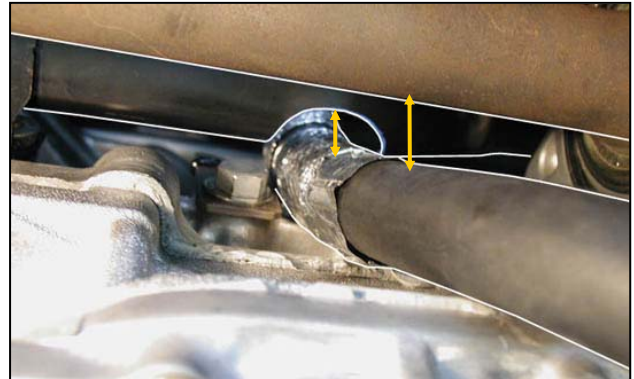

Important!
With out this proper clearance, there is a possibility of the return hose to fail and can cause fire and damage the engine.

3-9 Compression Pipe Installation

- (1) Install Compression pipe C-1 to the outlet of the turbo using the provided gasket and hardware.
(Parts used #6, 42, 63)



- (2) Loosen the hose clamp on the Radiator hose and rotate the hose so it comes up slightly.

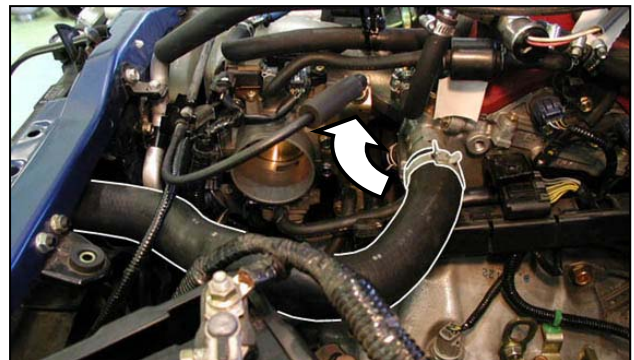

- (3) Install compression pipe C-2, and C-3 between C-1 and throttle body. Using provided hose and clamps.
- * Secure the bracket on C-2 to the factory air cleaner box mounting point.
 - * Make sure that the compression pipes does not interfere with shifter linkage movement. Also, check the clearance between the radiator hose and compression pipes.
- (Parts used #7, 8,32, 33,34, 38,39, 40,58)



- (4) Cut the master power vacuum hose by the intake manifold and install the 3-way fitting. Connect the 5Ø side to the actuator with the provided 5Ø hose.
- * Secure all the vacuum hose with zip ties to prevent the hose from coming off the fitting.
- (Parts used #28,50,52)

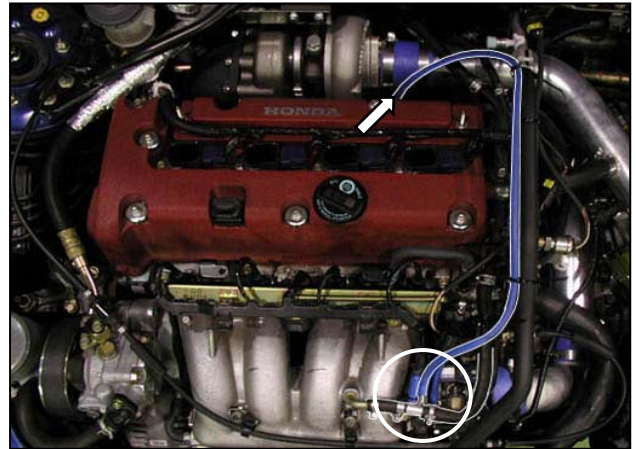

3-10 Intake Pipe Installation

- (1) Remove the top bolt on the Airinx air filter and remove the outer frame .
- (Parts used #10)

- (2) Install the provided hose adapter to the inner frame of the Airinx.
- (Parts used #11)

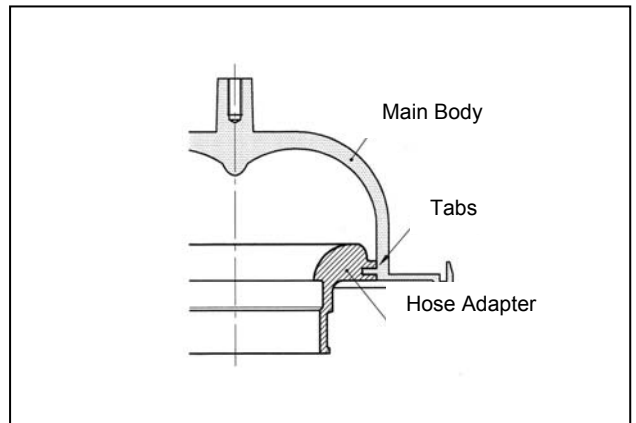

- (3) Reinstall the outer frame and secure it with the top bolt.

- (4) Remove the rubber plug on the Airinx and install the union fitting as shown.
- (Parts used #55)

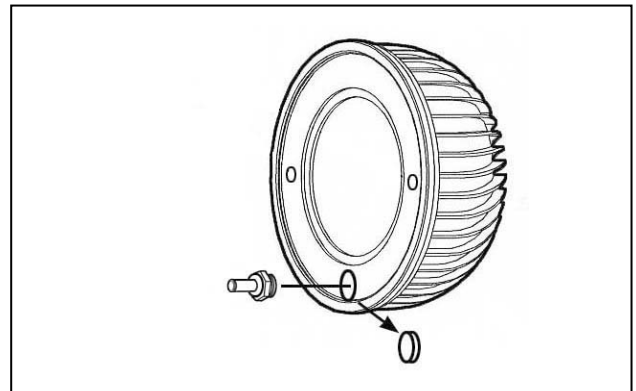

- (5) Install the provided intake air temperature sensor grommet to the suction pipe S-1 as shown.
(Parts used #4, 56)



- (6) Install stud bolts on to the inlet of the turbo, and install suction adapter using provided gasket and restrictor.
(Parts used #5,9,41,62)

Important!

The restrictor must be used with this turbo kit. With out it, the system can exceed the set boost level and can damage the engine.

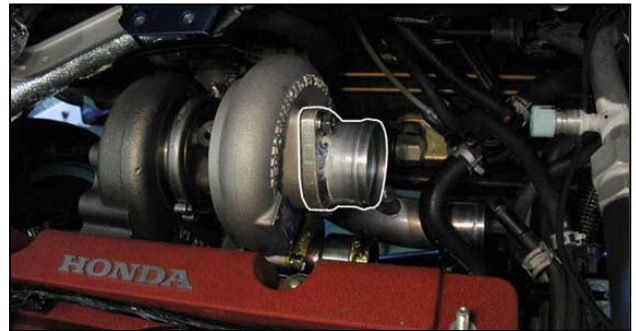

- (7) Install the Airinx air filter and S-1.
Secure the suction pipe bracket to the factory air cleaner box mounting point as shown.
* Make sure that the Airinx and the piping does rub up on to the battery.
(Parts used #32,39,53,58,59)

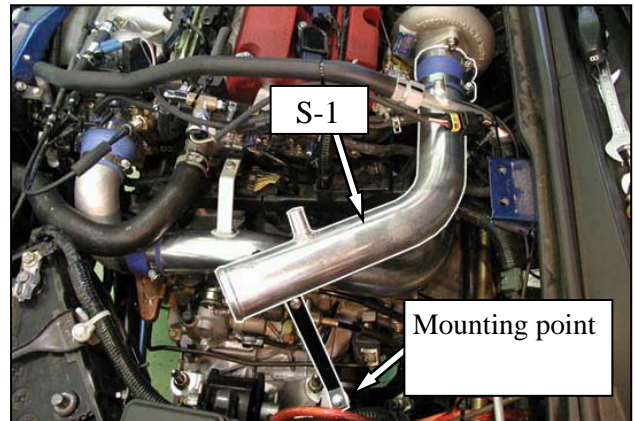

- (8) Connect the blow by tube from the valve cover to the S-1 with the provided 18Ø hose and clamps. Also connect the air assist control valve to Airinx using provided 8Ø hose and clamps.
(Parts used #29,31,35,37)

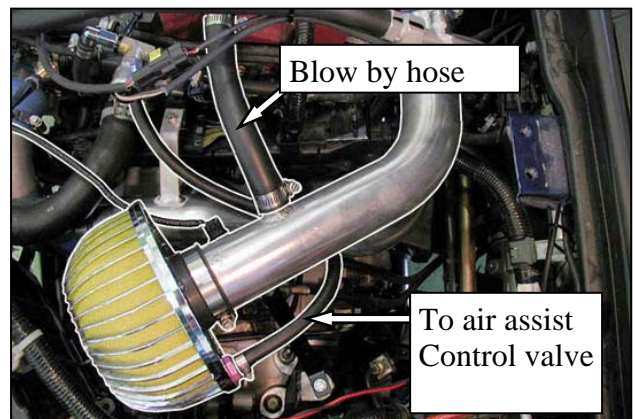

3-11 Down Pipe Installation

- (1) Install three stud bolt on the turbine housing as shown.

(Parts used #64)

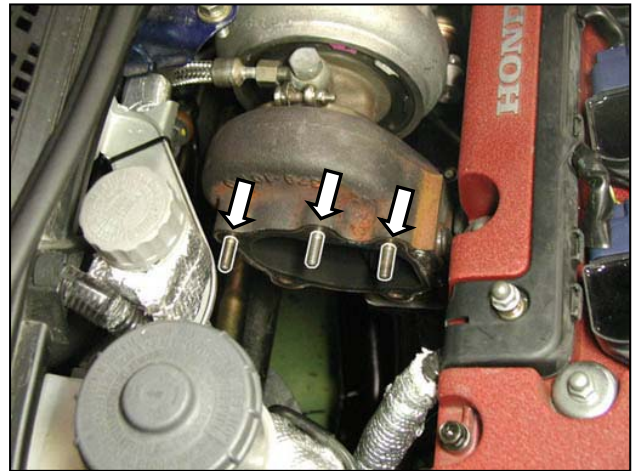

- (2) Check the fitment of the downpipe heat shield and install gasket on the catalytic converter end of the downpipe.

- * The heat shield will be reinstalled later once the downpipe is installed.

(Parts used #45, 48)



- (3) Install the downpipe to the turbo using provided gasket and hardware.

- * Make sure that there is enough clearance between the downpipe and the oil pressure line.

(Parts used #3,44,64,65)

- (4) Reinstall the catalytic converter and reconnect the o2 sensor connectors.

- * Reuse factory hardware to bolt the cat back on but the bolts with springs will require the provided nuts.

(Parts used #66)



- **Heat Shield Installation**

- (1) Install the turbine housing heat shield on to the downpipe using the provided M8 x 15mm bolts.

- * Make sure that there is enough clearance between the oil pressure line and the power steering line.

(Parts used #47,61)

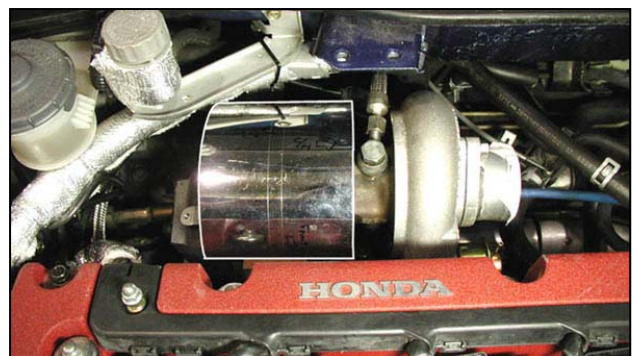

- (2) Install the down pipe heat shield on to the downpipe using the provided M6 x 10mm bolts.
(Parts used #48,57)



3-13 Fuel Injectors Installation

- (1) Disconnect the fuel injector connectors and ground wire on the fuel delivery tube and remove the fuel delivery tube.
* When removing the rail, use a rag to absorb the fuel that leaks out from the rail and hose.
- (2) Remove the injector clips off the rail, and remove the injectors.
- (3) Install the new injectors on to the rail.
* Lube the o-rings on the injectors and make sure not to damage the o-ring when installing them in to the rail.
(Parts used # 12)



- (4) Replace the stud bolts and spacers that holds the fuel rail down with the provided stud bolts and spacers.
- (5) Install the fuel rail assembly to the intake manifold.
- (6) Remove the injector wire cover and cut the factory injector connectors. Cut the provided injector harness to the same length of the cut factory connectors.
(Parts used # 13)

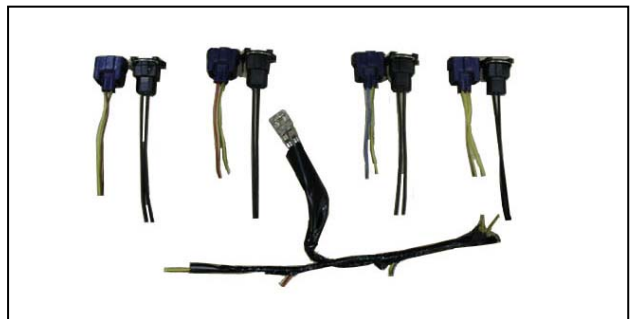
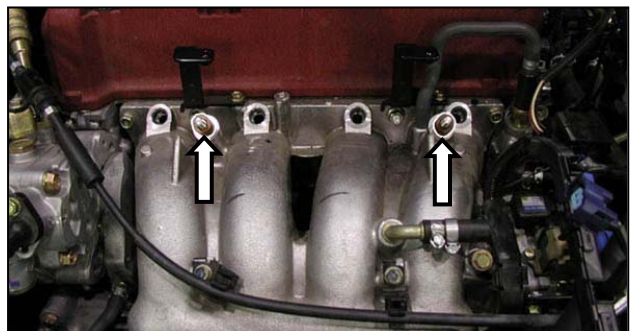

- (7) Solder the connectors to the harness and connect them to the injectors. Reconnect the ground wire back to the manifold.

How to Solder

1.Strip the wire ends.



2. Twist the two ends together.

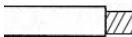

3.solder the wires

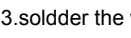

4. Tape up the exposed wires.

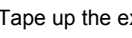

Make sure the wires are properly Soldered.

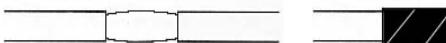

3-14 e-Manage Installation

- (1) Remove the cover under the glove box to access the ECU and ECU harness.
- (2) Install the Grey wire to the e-Manage I/J Harness (18Pin) connector as shown below.
- (3) Install the ignition harness wires in the e-Manage I/G Harness (12Pin) connector as shown below.
 - * When inserting the wires in to the connectors, make sure that the direction of the pins are correct and push them in all the way until they click in.

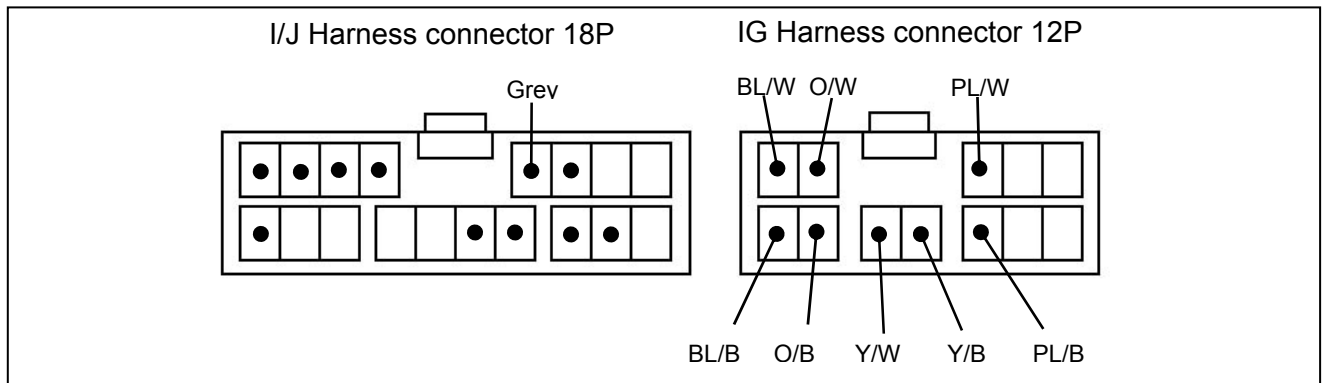

- (4) Connect the I/J and I/G Harness to the factory ECU harness as shown in the diagram on next page.

(Parts used #15, 16, 17)

Important

- This installation should only be performed by a trained specialist who is very familiar with the automobile's electrical and fuel management system.
- GReddy Performance Products Inc. is not responsible for any damage to the vehicle's electrical system caused by improper installation.
- It is recommended to solder all wires and use electrical tape or shrink wrap to insulate the wire connections.

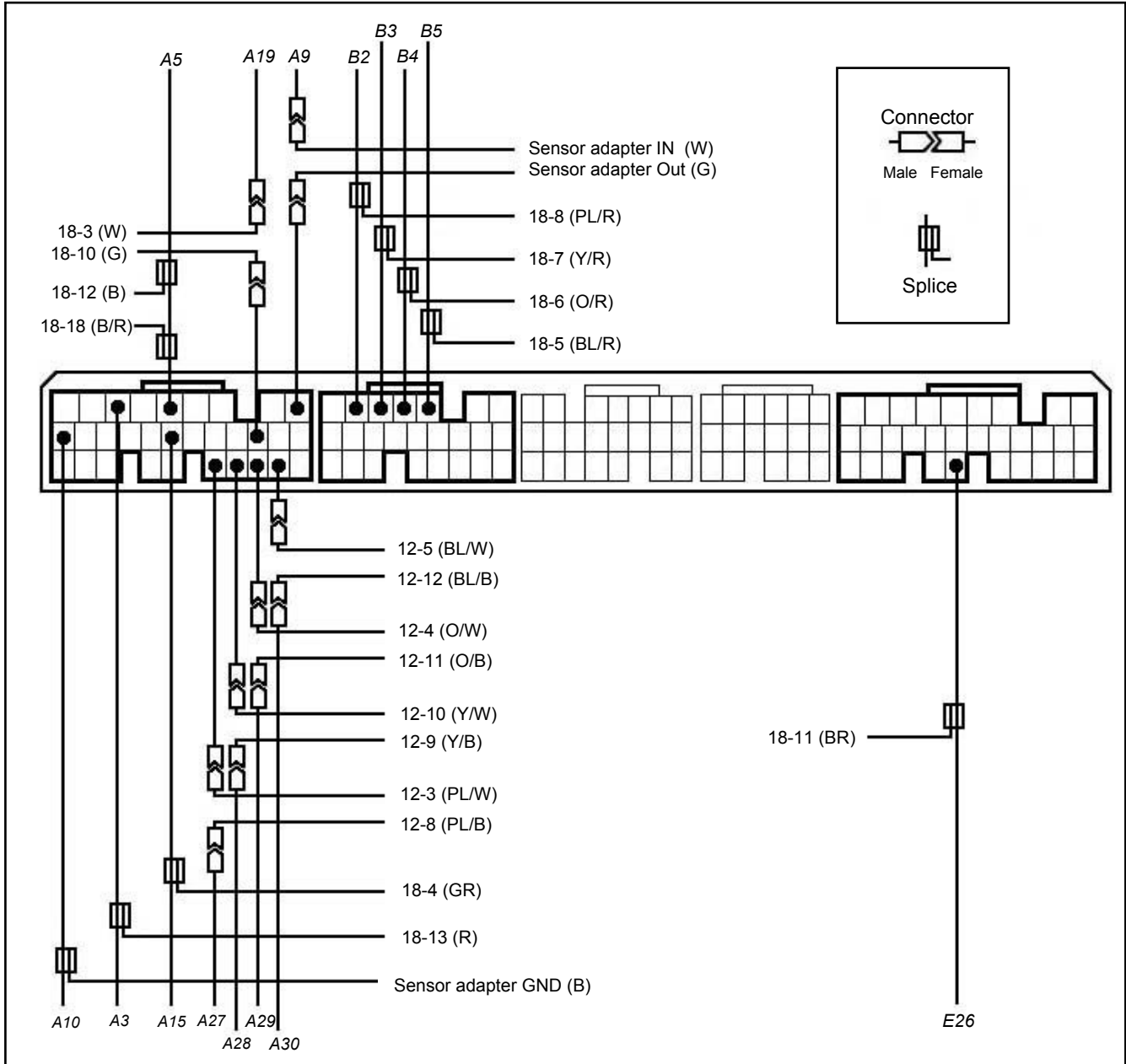
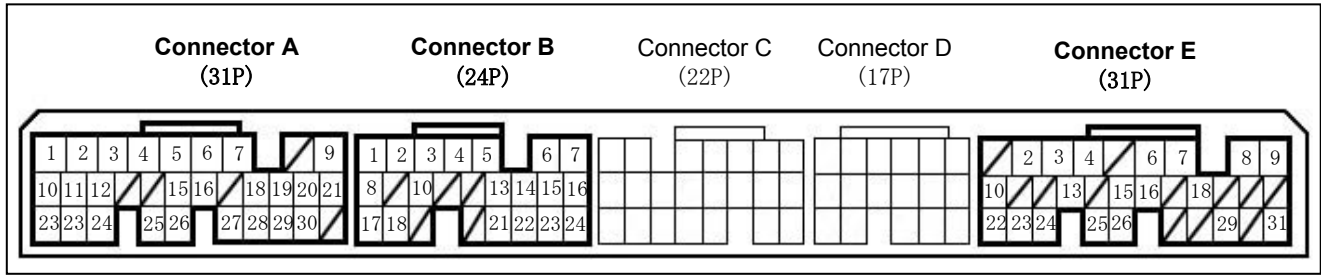

Color Code: **W** - White, **G** - Green, **B** - Black, **BL** - Blue, **BR** - Brown, **R** - Red, **GR** - Grey, **PL** - Purple, **Y** - Yellow, **O** - Orange

I/J Harness (18Pin)

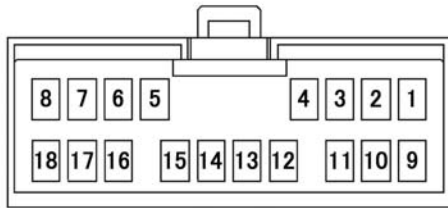

* Looking at harness side.

e-manage			Factory ECU		
Pin #	Wire Color	Description	ECU Pin #	Color	Code
3	White	MAP IN	A19(harness)	Green/Red	MAP
4	Grey	Throttle	A15	Red/Black	TPS
5	Blue/Red	INJ 1	B5	Brown	INJ 1
6	Orange/Red	INJ 2	B4	Red	INJ 2
7	Yellow/Red	INJ 3	B3	Blue	INJ 3
8	Purple/Red	INJ 4	B2	Yellow	INJ 4
10	Green	MAP OUT	A19 (ECU side)	Green/Red	MAP
11	Brown	RPM	E26	Blue	NEP
12	Black	GND	A5	Black	PG1
13	Red	+B	A3	Yellow/Black	IGP1
18	Black/Red	INJ GND	A5	Black	PG1

IG Harness (12Pin)

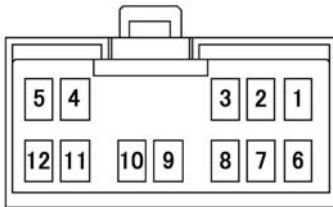

* Looking at harness side.

e-manage			Factory ECU		
Pin #	Wire Color	Description	ECU Pin #	Color	Code
3	Purple/White	IGT4 IN	A27(ECU side)	Brown	IGPLS4
4	Orange/White	IGT2 IN	A29(ECU side)	Blue/Red	IGPLS2
5	Blue/White	IGT1 IN	A30(ECU side)	Yellow/Green	IGPLS1
8	Purple/Black	IGT4 OUT	A27(Harness)	Brown	IGPLS4
9	Yellow/Black	IGT3 OUT	A28(Harness)	White/Blue	IGPLS3
10	Yellow/White	IGT3 IN	A28(ECU side)	White/Blue	IGPLS3
11	Orange/Black	IGT2 OUT	A29(Harness)	Blue/Red	IGPLS2
12	Blue/Black	IGT1 OUT	A30(Harness)	Yellow/Green	IGPLS1

Sensor Adapter		Factory ECU		
Wire Color	Description	ECU Pin #	Color	Code
White (male)	KNK IN	A9(Harness)	Red/Blue	KS
Green (female)	KNK OUT	A9(ECU side)	Red/Blue	KS
Black	KNK GND	A10	Green/Yellow	SG2

Important !

Make sure the all the wire connections are correct. If they are connected incorrectly, it can damage the e-Manage, ignition coils, and/or ECU.

- Reinstall the ECU back in its place, and secure the e-Manage next to the ECU.
 - * Avoid mounting the e-Manage unit in the area that would be exposed to direct sun light, moisture, or near heater outlet

3-16 Starting the Engine

- (1) Refill the engine oil to factory spec.
- (2) Check all the hoses and wires connection, then reconnect the negative side of the battery.
- (3) Turn the ignition to "ON" position 2-3 times to get fuel pressure. Then, check the injectors and the fuel rail for any fuel leaks.
*** Repair any fuel leaks before starting the engine. Starting the engine with a fuel leak can cause fire in the engine compartment and can be very dangerous.**
- (4) Remove the ECM fuse and crank the engine to get oil pressure to the turbo. (Until the oil light on the dash turns off) Check for any oil leaks, then reinstall the fuse and start the engine.
- (5) While idling, check for any oil, coolant, or air leaks.
- (6) After inspection, reinstall the under cover and other stock parts that was removed.
- (7) On the initial run, be sure to have a boost gauge to check the turbo-actuator setting. This turbo kit is preset to boost between 0.6kg/cm² to 0.6kg/cm² . It is very important that you monitor the boost pressure, and make sure not to over boost. Over boosting can cause engine damage.

This completes the Turbo Kit installation.

Important!

- **It is very important that you monitor the boost pressure, and make sure not to over boost. Over boosting can cause engine damage.**
- **GReddy Performance Products, Inc. is not responsible for any engine damage caused by over boosting (increased boost), modification to the kit, and/or misuse of the product. NO WARRANTY is offered.**
- **Due to lack of control over proper installation and use of this product, NO WARRANTY is offered for this kit.**

e-manage Information

Important!

- The e-manage included in this kit is preprogrammed for the this turbo kit.
- Do not attempt to adjust any of the setting in the e-manage.
- Any adjustments made can cause damage to the e-manage, engine and the factory ECU.



Important!

As of 5/25/03 this kit is not a street legal kit. Please ignore the label on the e-manage.

① ACTIVE L.E.D.

- When the ignition is turned on, it will illuminate and flash GREEN.
- When it reaches to the A.A.V. setting RPM range, it will illuminate and flash ORANGE.
- When an error is detected it will flash RED.

② INTERACTION L.E.D.

- This will illuminate when there is a connection with PC.

Checking Error Codes

When the unit is powered up and if there are any errors, the ACTIVE L.E.D will turn "RED" from "GREEN", and begin to flash.

If this happens shut the engine off and turn the ignition switch to "ON" position to go to Self Troubleshooting Mode. While in the Self Troubleshooting Mode, the L.E.D. will show the error code. Turn off the ignition. Check the error code in the chart below and fix the problem. The error code will show until the error is corrected.

Checking Error Code Chart

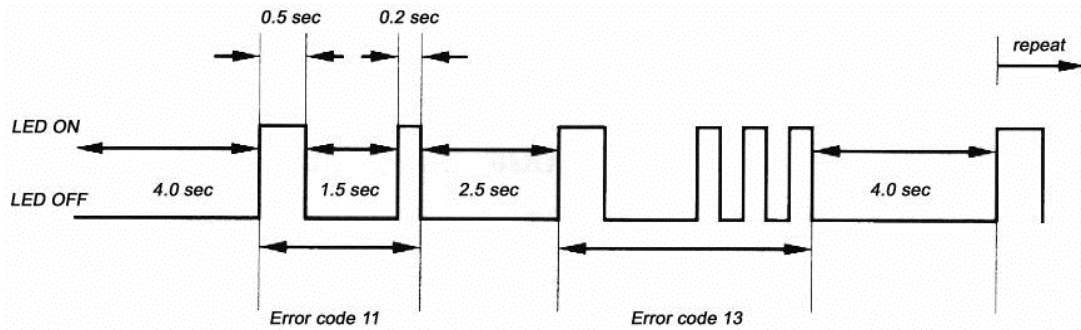

CODE	Error	Error description
11	Airflow Signal 1 input error	Incorrect wiring or disconnected Airflow Signal 1
15	Airflow voltage output error	Incorrect Airflow signal output wiring.
20	No Injector pulse from all	Not receiving an injector signal for Additional Injection Map
21	No Injector 1 pulse	Not receiving injector signal I/J CH-1 for Additional Injection Map
22	No Injector 2 pulse	Not receiving injector signal I/J CH-2 for Additional Injection Map
23	No Injector 3 pulse	Not receiving injector signal I/J CH-3 for Additional Injection Map
24	No Injector 4 pulse	Not receiving injector signal I/J CH-4 for Additional Injection Map
31	Incorrect Injector 1 pulse	Incorrect I/J CH-1 wire to e-Manage unit
32	Incorrect Injector 2 pulse	Incorrect I/J CH-2 wire to e-Manage unit
33	Incorrect Injector 3 pulse	Incorrect I/J CH-3 wire to e-Manage unit
34	Incorrect Injector 4 pulse	Incorrect I/J CH-4 wire to e-Manage unit
40	Improper order of Ignition input signal	Incorrect wiring order of the ignition signal wires.
41	No Ignition Signal 1 pulse	Not receiving the ignition signal to IG CH-1
42	No Ignition Signal 2 pulse	Not receiving the ignition signal to IG CH-2
43	No Ignition Signal 3 pulse	Not receiving the ignition signal to IG CH-3
44	No Ignition Signal 4 pulse	Not receiving the ignition signal to IG CH-4
49	No Ignition pulse	Not receiving the ignition signal to any of the channels
51	Incorrect Ignition 1 pulse	Incorrect IG CH-1 wire to e-Manage unit
52	Incorrect Ignition 2 pulse	Incorrect IG CH-2 wire to e-Manage unit
53	Incorrect Ignition 3 pulse	Incorrect IG CH-3 wire to e-Manage unit
54	Incorrect Ignition 4 pulse	Incorrect IG CH-4 wire to e-Manage unit
57	JP2 + 12V error	Incorrect Jumper setting (JP2)